

FiveEasy™ FiveEasy Plus™

pH Meter F20, FP20

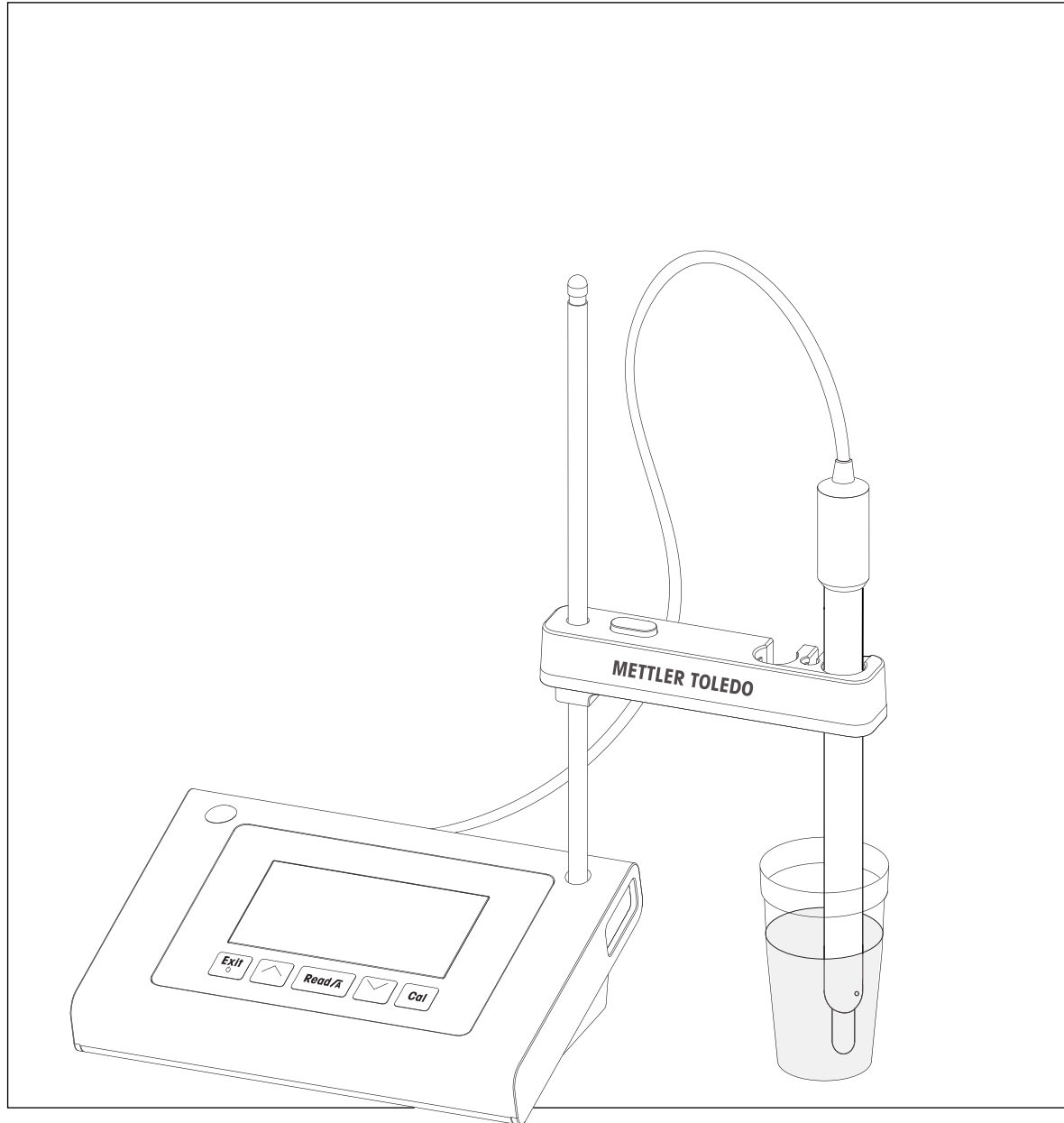

METTLER TOLEDO

Table of Contents

1	Introduction	3
2	Safety Measures	4
2.1	Definition of signal warnings and symbols.....	4
2.2	Product specific safety notes	4
3	Design and Function	7
3.1	Overview.....	7
3.2	Connections on the instrument	7
3.3	Keypad F20	8
3.4	Keypad FP20	9
3.5	Display and icons F20	10
3.6	Display and icons FP20	11
3.7	Setup menu navigation.....	12
3.8	Measurement modes.....	12
4	Putting into Operation	13
4.1	Scope of delivery	13
4.2	Sensor holder installation.....	13
4.3	Connecting the power adapter	13
4.4	Connecting sensors.....	14
4.5	Switching the instrument on and off	14
5	Operation of the Instrument	16
5.1	General settings.....	16
5.1.1	Endpoint Formats.....	16
5.1.2	Temperature capture.....	16
5.1.3	Predefined buffer groups	16
5.1.4	Temperature unit (FP20 only).....	16
5.2	Performing a calibration	18
5.2.1	Performing a 1-point calibration	18
5.2.2	Performing a 2-point calibration	18
5.2.3	Performing a 3-point calibration	18
5.2.4	Performing a 4- or 5-point calibration	19
5.3	Performing a measurement.....	20
5.3.1	Measurement mode.....	20
5.3.2	Performing a pH measurement	20
5.3.3	Performing a mV measurement.....	20
5.4	Using the memory (FP20 only)	21
5.4.1	Storing a measurement result	21
5.4.2	Recalling from memory.....	21
5.4.3	Clearing the memory	21
5.5	Print out (FP20 only)	21
5.5.1	Connection and configuration	21
5.5.2	Print-out following measurement / calibration.....	21
5.5.3	Printing from memory.....	21
5.6	Data export to PC (FP20 only)	21
5.7	Self-diagnosis	22
5.8	Factory reset.....	22
6	Maintenance	23
6.1	Cleaning the housing	23
6.2	Electrode maintenance	23
6.3	Error messages	24
6.4	Error limits	24
6.5	Disposal	24

7	Product Portfolio	25
8	Accessories	26
9	Technical Data F20	28
10	Technical Data FP20	30
11	Appendix	32

1 Introduction

Thank you for purchasing this high quality METTLER TOLEDO laboratory meter. With the new FiveEasy™ and FiveEasyPlus™ bench line instruments for pH and conductivity measurement, we wish to simplify your measuring process and your workflows.

FiveEasy™ and FiveEasy Plus™ are much more than just a series of bench meters with an excellent price/performance ratio. The meters offer a number of user-friendly features, including:

- **Optimized ease of use**
simple menus for quick and easy operation
- **Small footprint**
while boasting a large display, the instrument requires little benchtop space
- **Flexibility**
a number of useful accessories are available to further simplify your lab (e.g. printers, sensors, buffers and solutions)

2 Safety Measures

2.1 Definition of signal warnings and symbols

Safety notes are marked with signal words and warning symbols. These show safety issues and warnings. Ignoring the safety notes may lead to personal injury, damage to the instrument, malfunctions and false results.

Signal words

WARNING for a hazardous situation with medium risk, possibly resulting in severe injuries or death if not avoided.

CAUTION for a hazardous situation with low risk, resulting in damage to the device or the property or in loss of data, or minor or medium injuries if not avoided.

Attention (no symbol)
for important information about the product.

Note For useful information about the product.

Warning symbols



General hazard



Toxic substance



Inflammable or explosive substance

2.2 Product specific safety notes

Your instrument represents state-of-the-art technology and complies with all recognized safety rules, however, certain hazards may arise in extraneous circumstances. Do not open the housing of the instrument; it does not contain any parts that can be maintained, repaired or replaced by the user. If you experience problems with your instrument, contact your authorized METTLER TOLEDO dealer or service representative.

Intended use



This instrument is designed for a wide range of applications in various areas and is suitable for measuring pH.

The use therefore requires knowledge and experience in working with toxic and caustic substances.

The manufacturer shall not be held liable for any damage resulting from incorrect usage divergent to the operating instructions. Furthermore, the manufacturer's technical specifications and limits must be adhered to at all times and in no way exceeded.

Location



The instrument has been developed for indoor operation and may not be used in explosive environments.

Use the instrument in a location which is suitable for the operation, protected from direct sunlight and corrosive gases. Avoid powerful vibrations, excessive temperature fluctuations and temperatures below 0 °C and above 40 °C.

Protective Clothing

It is advisable to wear protective clothing in the laboratory when working with hazardous or toxic substances.



A lab coat should be worn.



Suitable eye protection such as goggles should be worn.



Use appropriate gloves when handling chemicals or hazardous substances, checking their integrity before use.

Safety notes



WARNING

Chemicals

All relevant safety measures are to be observed when working with chemicals.

- 1 Set up the instrument in a well-ventilated location.
- 2 Any spills should be wiped off immediately.
- 3 When using chemicals and solvents, comply with the instructions of the producer and the general lab safety rules.



WARNING

Flammable solvents

All relevant safety measures must be observed when working with flammable solvents and chemicals.

- 1 Keep all sources of flame away from the workplace.
- 2 When using chemicals and solvents, comply with the instructions of the producer and the general lab safety rules.

FCC Rules

This device complies with Part 15 of the FCC Rules and Radio Interference Requirements of the Canadian Department of Communications. Operation is subject to the following conditions: (1) this device may not cause harmful interference, and (2) this device must accept any interference received, including interference that may cause undesired operation.

This equipment has been tested and found to comply with the limits for a Class A digital device, pursuant to Part 15 of the FCC rules. These limits are designed to provide reasonable protection against harmful interference when the equipment is operated in a commercial environment. This equipment generates, uses, and can radiate radio frequency energy and, if not installed and used in accordance with the instruction manual, may cause harmful interference to radio communications. Operation of this equipment in a residential area is likely to cause harmful interference in which case the user will be required to correct the interference at his own expense.

3 Design and Function

3.1 Overview

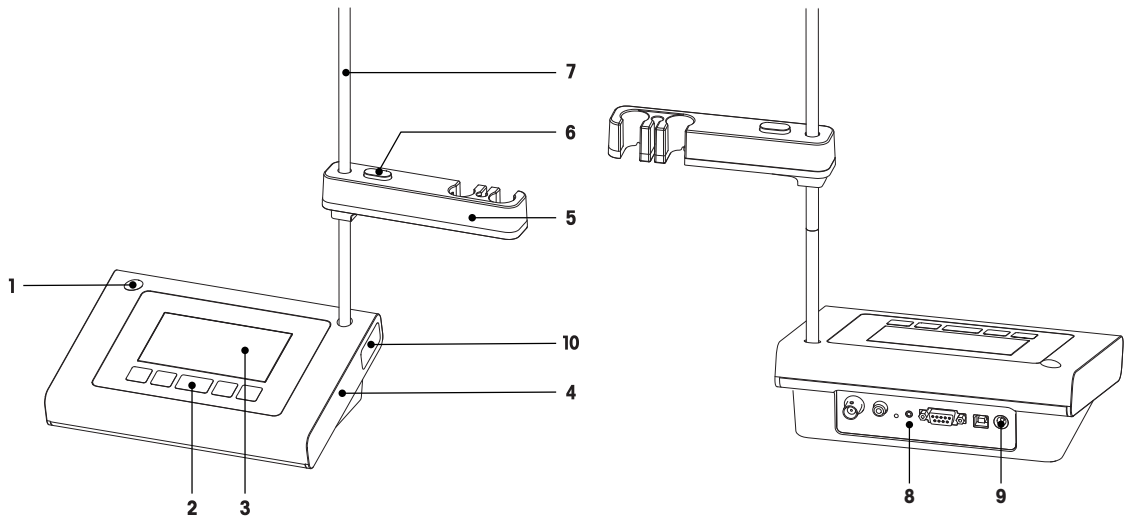

- | | |
|---|---|
| <ul style="list-style-type: none"> 1 Left handed mounting position for sensor holder 2 Keypad 3 Display 4 Housing 5 Sensor holder | <ul style="list-style-type: none"> 6 Release button height adjustment 7 Rod stand (height adjustment) 8 Connection board 9 DC connection 10 Storage compartment for electrode stand |
|---|---|

3.2 Connections on the instrument

FP20

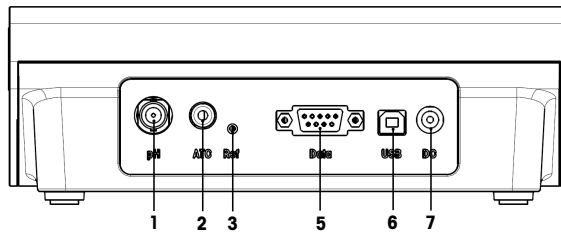

- 1** Socket for pH sensor (BNC)
- 2** Socket for temperature sensor (RCA - Cinch)
- 3** Socket for reference electrode
- 4** Socket for analog mV signal output



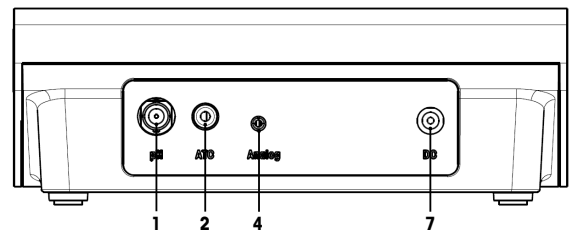

F20

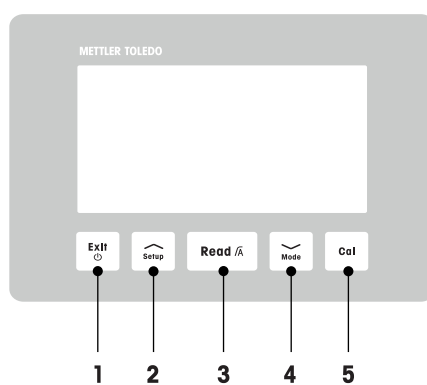

- 5** RS232 interface to printer
- 6** USB-B interface to PC
- 7** DC socket for power supply





3.3 Keypad F20

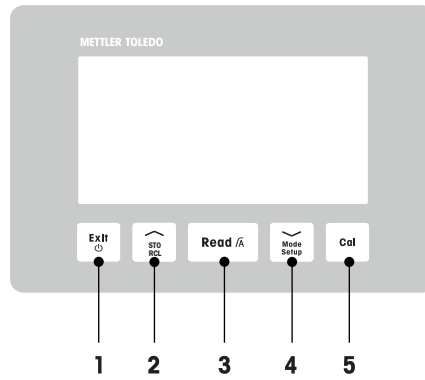

	Key	Naming	Press and release (measurement mode)	Press and hold for 1 second (measurement mode)	Press and release (other mode)
1		On / Off / Exit	<ul style="list-style-type: none"> Switch meter on 	<ul style="list-style-type: none"> Switch meter off 	<ul style="list-style-type: none"> Back to measurement screen
2		Setup	<ul style="list-style-type: none"> Open setup 		<ul style="list-style-type: none"> Increase value during setting
3		Read / Endpoint format	<ul style="list-style-type: none"> Start or endpoint measurement 	<ul style="list-style-type: none"> Set auto endpoint on / off 	<ul style="list-style-type: none"> Confirm setting
4		Mode	<ul style="list-style-type: none"> Change measurement mode (pH / mV) 		<ul style="list-style-type: none"> Decrease value during setting
5		Calibration	<ul style="list-style-type: none"> Start calibration 	<ul style="list-style-type: none"> Recall calibration data 	

3.4 Keypad FP20



	Key	Naming	Press and release (measurement mode)	Press and hold for 1 second (measurement mode)	Press and release (other mode)
1		On / Off / Exit	<ul style="list-style-type: none"> Switch meter on 	<ul style="list-style-type: none"> Switch meter off 	<ul style="list-style-type: none"> Back to measurement screen
2		Store / Recall	<ul style="list-style-type: none"> Store current reading to memory 	<ul style="list-style-type: none"> Recall memory data 	<ul style="list-style-type: none"> Increase value during setting Scroll up through the memory
3		Read / Endpoint format	<ul style="list-style-type: none"> Start or endpoint measurement 	<ul style="list-style-type: none"> Set auto endpoint on / off 	<ul style="list-style-type: none"> Confirm setting
4		Mode / Setup	<ul style="list-style-type: none"> Change measurement mode (pH / mV) 	<ul style="list-style-type: none"> Enter set up mode 	<ul style="list-style-type: none"> Decrease value during setting Scroll down through the memory
5		Calibration	<ul style="list-style-type: none"> Start calibration 	<ul style="list-style-type: none"> Recall calibration data 	

3.5 Display and icons F20

When turning on the instrument, the startup screen appears for 3 seconds. The startup screen shows all icons which can appear on the display. In the following table you find a short description of these icons.

Startup screen

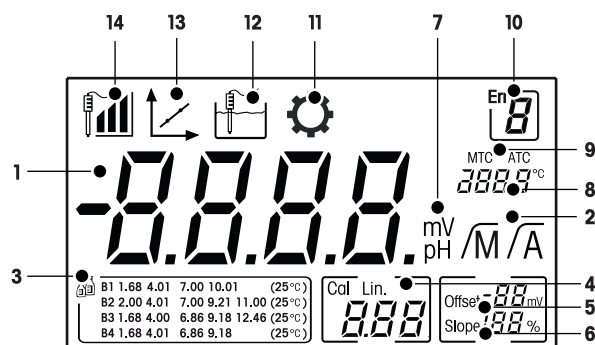

	Icon	Description
1	---	pH measurement value
2	\sqrt{A} / \sqrt{M}	Endpoint format: \sqrt{A} Automatic \sqrt{M} Manual
3		Buffer/Standard setting
4	Cal / Lin.	Calibration type: Lin. Linear
5	Offset	Offset reading
6	Slope	Slope is one of two quality indicators for the attached sensor and is determined during calibration.
7	mV / pH	Currently used measurement unit
8	---	Temperature information
9	MTC / ATC	MTC (Manual temperature capture) ATC (Automatic temperature capture)
10		Error code
11		Setup mode
12		Measurement mode
13		Calibration mode: Indicates calibration mode and appears whenever you are performing a calibration or reviewing calibration data.
14		Electrode performance Slope: 95-105% / Offset: \pm 0-20 mV (Electrode in good condition) Slope: 90-94% / Offset: \pm 20-35 mV (Electrode needs cleaning) Slope: 85-89% / Offset: \geq 35 mV or \leq - 35 mV (Electrode is faulty)



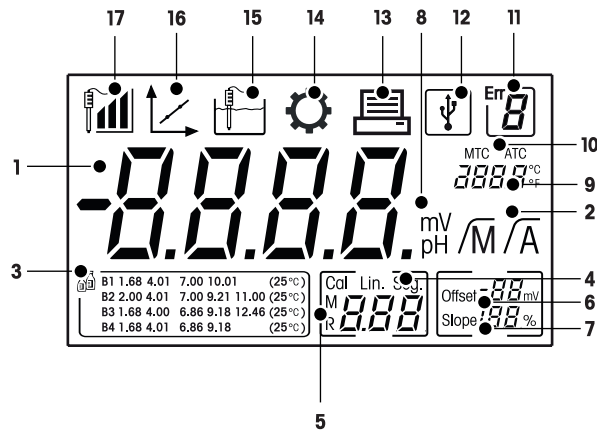

3.6 Display and icons FP20

When turning on the instrument, the startup screen appears for 3 seconds. The startup screen shows all icons which can appear on the display. In the following table you find a short description of these icons.

Startup screen





	Icon	Description
1	---	pH measurement value
2	\sqrt{A} / \sqrt{M}	Endpoint format: \sqrt{A} Automatic \sqrt{M} Manual
3		Buffer setting
4	Cal / Lin. / Seg.	Calibration type: Lin. Linear Seg. Segmented
5	M --	Memory information
6	Offset	Offset reading is determined during calibration
7	Slope	Slope is determined during calibration. Slope and offset are the two indicators to determine the quality of the attached sensor. Refer to the InLab® sensor's quality certificate for more information.
8	mV / pH	Currently used measurement unit
9	---	Temperature information
10	MTC / ATC	MTC (Manual temperature capture) ATC (Automatic temperature capture)
11		Error messages
12		USB connection to PC
13		Data transfer activated
14		Setup mode
15		Measurement mode

	Icon	Description
16		Calibration mode: Indicates calibration mode and appears whenever you are performing a calibration or reviewing calibration data.
17		Electrode performance  Slope: 95-105% / Offset: \pm 0-20 mV (Electrode in good condition)  Slope: 90-94% / Offset: \pm 20-35 mV (Electrode needs cleaning)  Slope: 85-89% / Offset: \geq 35 mV or \leq - 35 mV (Electrode is faulty)

3.7 Setup menu navigation

For general navigation in the setup menu read the following information:

- Press and hold **Setup** to enter the setup menu.
- Press **Exit** to exit the setup menu.
- Use  and  do increase or decrease values.
- Press **Read** to confirm a change.

The following parameters can be changed in the order as shown.

Parameter	Description	Range
MTC	Manual temperature setting	0.0...100.0 °C / 32.0...212 °F
	Buffer standard setting	B1, B2, B3, B4
°C, °F	Temperature unit	°C, °F

3.8 Measurement modes

With the meter it is possible to measure the following parameters of a sample:

- pH
- mV

To change the measurement mode, press **Mode**.

4 Putting into Operation

4.1 Scope of delivery

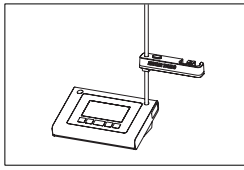

FiveEasy™ F20 instrument
FiveEasy Plus™ FP20 instrument
for pH/mV measurement

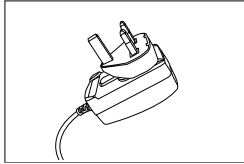

Power adapter

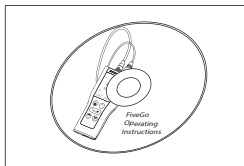

CD-ROM including operating instructions

4.2 Sensor holder installation

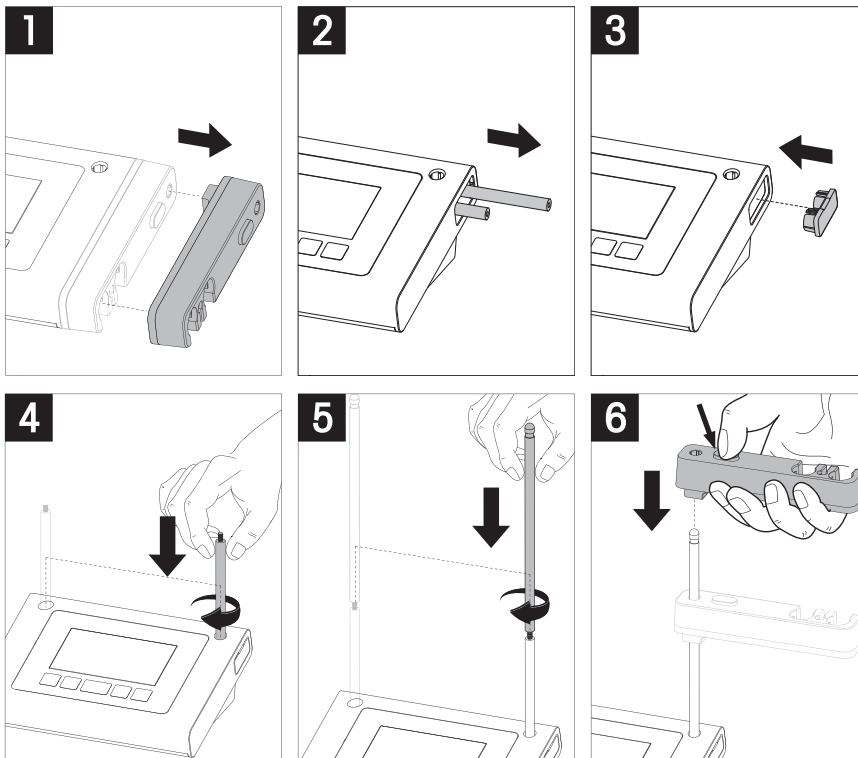

4.3 Connecting the power adapter

The instrument is supplied with an universal AC adapter. The AC adapter is suitable for all line voltages in the range of 100 to 240 V, 50/60 Hz.

Attention

- Before operating, check cables for damage!
- Ensure the cables are tidily arranged so that they cannot be damaged or interfere with the installation!
- Take care that the AC adapter does not come into contact with liquids!
- The power plug must be accessible at all times!

- 1 Insert the correct connector plug into the AC adapter until it is completely inserted.

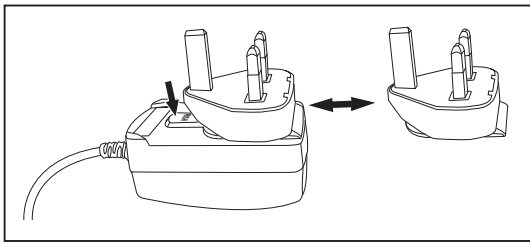

- 2 Connect the cable of the AC adapter with the DC socket of the instrument.

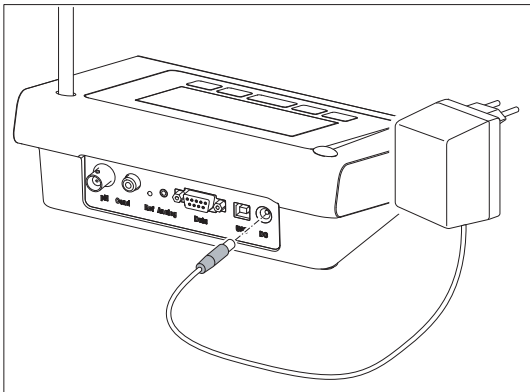

- 3 Plug the AC adapter into the wall socket.



Note

To remove the connector plug, push the release button and withdraw the connector plug.

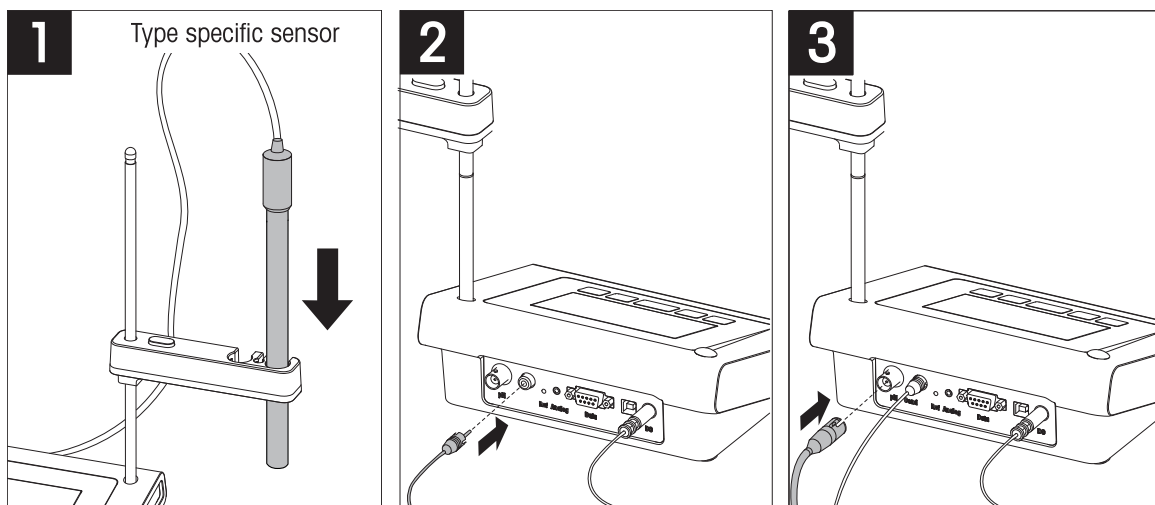
4.4 Connecting sensors



4.5 Switching the instrument on and off

- 1 Press and release  to switch on the instrument.
 - ➔ All segmented digital numbers and icons are displayed for 2 seconds. After that the installed software version appears (e.g. 1.00) and the instrument is ready for use.
- 2 Press  for 3 seconds and release to switch off the instrument.

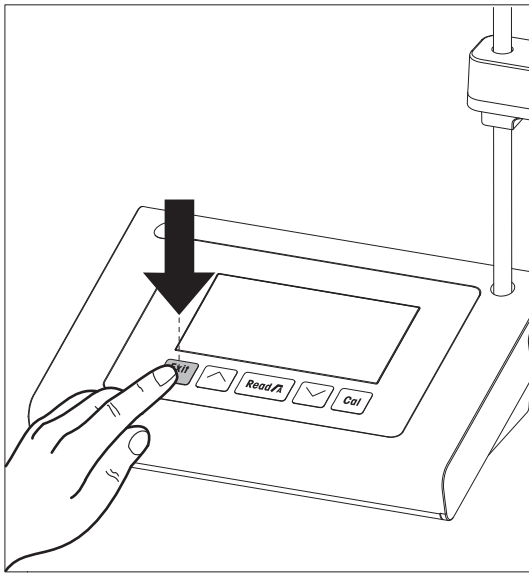

5 Operation of the Instrument

5.1 General settings

5.1.1 Endpoint Formats

The FiveEasy™ and FiveEasy Plus™ offers two different endpoint formats, automatic and manual. To switch between the automatic and manual endpoint modes, press and hold **Read**.

Automatic endpoint

With the automatic endpoint, the measurement stops automatically as soon as the input signal is stable. This ensures an easy, quick and precise measurement.

Manual endpoint

Unlike the automatic endpoint, user interaction is required to stop the measurement reading in manual mode. To manually endpoint a measurement, press **Read**.

5.1.2 Temperature capture

Automatic temperature capture (ATC)

For better accuracy, we recommend the use of either a sensor with a built-in or a separate temperature probe. If a temperature probe is recognized by the meter, **ATC** and the sample temperature are displayed.

Note

The meter accepts NTC 30 kΩ temperature sensors.

Manual temperature capture (MTC)

If the meter does not detect a temperature probe, it automatically switches to the manual temperature mode and **MTC** appears. The entered MTC temperature is used for temperature compensation.

- 1 To set the MTC temperature, press and hold **Setup**.
 - ➔ The temperature value is blinking. The default setting is 25 °C.
- 2 Select the temperature value by using \swarrow and \searrow .
- 3 Press **Read** to confirm your settings.
- 4 Continue with buffer group selection or press **Exit** to return to measurement screen.

5.1.3 Predefined buffer groups

The buffer group is selected in the setup menu.

B1	1.68	4.01	7.00	10.01		(at 25 °C)
B2	2.00	4.01	7.00	9.21	11.00	(at 25 °C)
B3	1.68	4.00	6.86	9.18	12.46	(at 25 °C)
B4	1.68	4.01	6.86	9.18		(at 25 °C)

- After confirmation of the MTC temperature, the current buffer group is blinking.
- 1 Select the buffer group by using \swarrow and \searrow .
 - 2 Press **Read** to confirm.
 - 3 Continue with temperature unit setting or press **Exit** to return to measurement screen.

NOTICE

It is not needed to calibrate a pH electrode with all pH values of a buffer group. Select the buffer group which contains the ones you are using for calibration. During calibration, the order in which the buffers are used is not relevant. The instrument has an auto buffer recognition function. This allows to calibrate in any order.

5.1.4 Temperature unit (FP20 only)

The temperature unit is changed in the setup menu.

- After selection and confirmation of the predefined buffer group the temperature unit starts blinking.
- 1 Select the temperature unit (°C or °F) using \swarrow and \searrow .



- 2 Press **Read** to confirm and get back to the measurement screen.

5.2 Performing a calibration

For better accuracy, we recommend the use of either a sensor with a built-in or a separate temperature probe. If you use the MTC mode, you should enter the correct temperature value and keep all buffer and sample solutions at the set temperature. To ensure the most accurate pH reading, you should perform a calibration regularly.

The FiveEasy™ pH meter allows you to run 1-, 2- and 3-point calibrations and the FiveEasy Plus™ pH meter allows you to run 1-, 2-, 3-, 4- and 5-point calibrations. If you select your calibration buffer group from one of the four predefined groups stored in the meter, the buffers are automatically recognized and displayed during calibration (auto buffer recognition).



5.2.1 Performing a 1-point calibration

- An electrode is connected to the instrument.
 - 1 Place the electrode in a calibration buffer.
 - 2 Press **Cal**.
 - ➔  and  appear on the display.
During measurement the pH value based on the previous calibration is shown. Depending on the endpoint format, the instrument stops measuring when the signal is stable (auto endpoint) or after pressing **Read** (manual endpoint).
 - ➔ At endpoint,  disappears from the display and the pH value of the recognized buffer at measured temperature is shown.
 - 3 If you do not want to proceed with the 2-point calibration, press **Read** to finish the 1-point calibration.
– or –
If you want to reject the 1-point calibration press **Exit**.
– or –
Proceed with next calibration point and go to [Performing a 2-point calibration ▶ Page 18].

Note

With the 1-point calibration only the offset is adjusted. If the sensor was previously calibrated with multi-point calibration the previously stored slope will remain. Otherwise the theoretical slope (100 %) will be used.

5.2.2 Performing a 2-point calibration

- Perform the first calibration point as described in the section [Performing a 1-point calibration ▶ Page 18].
 - 1 Rinse the electrode with deionized water.
 - 2 Place the electrode in the next calibration buffer and press **Cal**.
 - ➔  and  appear on the display.
During measurement the pH value based on the previous calibration is shown. Depending on the endpoint format, the instrument stops measuring when the signal is stable (auto endpoint) or after pressing **Read** (manual endpoint). Slope and offset are then calculated.
 - ➔ At endpoint,  disappears from the display and the pH value of the recognized buffer at measured temperature is shown.
 - 3 If you do not want to proceed with a 3-point calibration press **Read** to finish and save the 2-point calibration.
-or-
if you want to reject the 2-point calibration, press **Exit**.
-or-
if you want to proceed with the next calibration point go to [Performing a 3-point calibration ▶ Page 18].

Note

With the 2-point calibration, both slope and offset are updated and shown on the right side of the display

5.2.3 Performing a 3-point calibration

- Perform the same steps as described in [Performing a 2-point calibration ▶ Page 18].
 - Repeat steps 1, 2 and 3 of [Performing a 2-point calibration ▶ Page 18] for the third calibration point.

Note

With the 3-point calibration, both slope and offset are updated and shown on the right side of the display. The slope and offset values are calculated using least square method through the three calibration points (linear calibration). The FP20 offers the option of segmented calibration, where slope and offset are calculated individually for each pair of adjacent buffers. Segmented calibration is only meaningful for calibration with 3 or more points.

5.2.4 Performing a 4- or 5-point calibration

- Perform the same steps as described in the section [Performing a 2-point calibration ▶ Page 18].
- Repeat steps 1, 2 and 3 of the section [Performing a 2-point calibration ▶ Page 18] for the fourth or fifth calibration point.

Note

With the 4-point and 5-point calibration, both slope and offset are updated and shown on the right side of the display.

5.3 Performing a measurement

5.3.1 Measurement mode

Both FiveEasy™ and FiveEasy Plus™ pH/mV meter offer two different reading modes: pH and mV.

- Press the **Mode** button to switch between pH and mV mode.

5.3.2 Performing a pH measurement

- An electrode is connected to the instrument.
 - Make sure that the pH reading mode is selected.
- 1 Place the electrode in the sample and press **Read** to start the measurement.
 - ➔ The decimal point blinks.
 - ➔ The display shows the pH of the sample.
 - ➔ If the automatic endpoint is selected, and the signal has stabilized, the display freezes, \sqrt{A} appears and the decimal point stops blinking. In case the **Read** button was pressed before the automatic endpoint, the display freezes and \sqrt{M} appears.
 - 2 If the manual endpoint is chosen, press **Read** to manually stop the measurement. The display freezes and \sqrt{M} appears.

Note

Press and hold **Read** to switch between the automatic and manual endpoint format.

5.3.3 Performing a mV measurement

- An electrode is connected to the instrument.
- Make sure that the mV mode is selected.
- Continue as described in steps 1 and 2 of the section [Performing a pH measurement ▶ Page 20].

5.4 Using the memory (FP20 only)

5.4.1 Storing a measurement result



The instrument can store up to 200 endpointed results.

- Press **STO** when the measurement has endpointed.
 - ➔ **M001** indicates that one result has been stored, and **M200** that the maximum of 200 results have been stored.

NOTICE

If you press **STO** when **M200** is displayed, **Err 8** indicates that the memory is full. To store further data, you will have to clear the memory.

5.4.2 Recalling from memory

- 1 Press and hold **RCL** to recall the stored values.
- 2 Press  or  to scroll through the stored results.
 - ➔ **MR 001** to **MR 200** indicates which result is currently displayed.
- 3 Press **Exit** to go back to the measurement screen.

5.4.3 Clearing the memory

- 1 Press and hold **RCL** to recall the stored values from memory.
- 2 Press **RCL** until **ALL** appears on the display.
- 3 Press **Read** to delete all measurement results.
 - ➔ **CLr** starts blinking on the display.
- 4 Press **Read** to confirm the deletion
 - or -
 - Press **Exit** to cancel the deletion.

5.5 Print out (FP20 only)

5.5.1 Connection and configuration

A printer can be connected to the RS-232 interface of the FP20. The use of the RS-P25, RS-P26 or RS-P28 printer is recommended, because they recognize the FP20 and adjust the correct parameters automatically.

In case a different printer is used, the following parameters need to be set:

Baud-rate: 1,200 bps

Data bit: 8 bit

Parity: None

Stop bit: 1

5.5.2 Print-out following measurement / calibration

If a printer is connected to the FP20, a print out is automatically generated after each endpointed measurement or calibration.

5.5.3 Printing from memory

When scrolling through the memory, you can print the entry that is currently viewed by pressing and holding the key **RCL**.

5.6 Data export to PC (FP20 only)

Measurement data can be transferred to a PC after each endpointed measurement or calibration, using **EasyDirect pH** PC software.

To transfer the currently viewed memory data to the PC, press and hold the **RCL**.

5.7 Self-diagnosis

- 1 Switch the meter on.
- 2 Press **Read** and **Cal** simultaneously until the meter displays the full screen.
 - ➔ Each icon blinks one after the other whereby you can check if all icons are correctly shown on the display.
 - ➔ After that, **b** starts to blink and 5 hardkey-icons are shown on the display.
- 3 Press any hardkey.
 - ➔ The specific icon disappears from the display.
- 4 Press each hardkey once.
 - ➔ When the self-diagnosis is completed successfully, **PAS** appears. If the self-diagnosis has failed, **Err 2** appears.

NOTICE

You must press all hardkeys within 1 minute. Otherwise **FAL** appears and the self-diagnosis has to be redone.

5.8 Factory reset



NOTICE

Loss of data!

With a factory reset all user-specific settings will be set to standard. Also all data memories will be deleted.

- The instrument is switched off.
- 1 Press and hold **Read**, **Cal** and **Exit** simultaneously for 2 seconds.
 - ➔ **RST** appears on the display.
 - 2 Press **Read**.
 - 3 Press **Exit**.
 - ➔ The instrument switches off.
 - ➔ All settings are reset.

6 Maintenance

6.1 Cleaning the housing



NOTICE

Damage to the instrument!

Ensure that no liquid enters the interior of the instrument.
Wipe off any spills immediately.

The meter does not require any maintenance other than an occasional wipe with a damp cloth. The housing is made of acrylonitrile butadiene styrene (ABS). This material is sensitive to some organic solvents, such as toluene, xylene and methyl ethyl ketone (MEK).

- Clean the housing of the instrument using a cloth dampened with water and a mild detergent.

6.2 Electrode maintenance

- Make sure pH electrodes are always kept filled with the appropriate filling solution.
- For maximum accuracy, any filling solution that may have crystallized and encrusted the outside of the electrode should be removed with deionized water.
- Always store the electrode according to the manufacturer's instructions and do not allow it to dry out.

If the electrode slope falls rapidly, or if the response becomes sluggish, the following procedures may help. Try one of the following, depending on your sample. Run a new calibration after treatment.

Symptom	Procedure
Fat or oil build-up.	Degrease the membrane with cotton wool soaked in either acetone or a soap solution.
Membrane has dried out.	Soak the tip of the electrode overnight in 0.1 M HCl.
Protein build-up in the diaphragm.	Remove deposits by soaking the electrode in an HCl/pepsin solution.
Silver sulfide contamination.	Remove deposits by soaking electrode in a thiourea solution.

Note

- Cleaning and filling solutions should be handled with the same care as that given to toxic or corrosive substances.
- For pH electrode trouble shooting you can also turn to www.electrodes.net

6.3 Error messages

Error	Description	Resolution
Err 1	Memory access error	Reset to factory settings
Err 2	Self-diagnosis failed	Repeat the self-diagnosis procedure and make sure that you finish pressing all five keys within two minutes.
Err 3	Measured values out of range	Make sure that the electrode wetting cap has been removed and the electrode is properly connected and placed in the sample solution. If no electrode is connected, put the shorting plug on the socket.
Err 4	Calibration buffer temperature out of range (5 to 40 °C)	Keep the temperature within the range for calibration (5 to 40 °C).
Err 5	Offset out of range	Make sure you have the correct buffer and that it is fresh. Disconnect, clean and/or replace the electrode.
Err 6	Slope out of range	Make sure you have the correct buffer and that it is fresh. Disconnect, clean and/or replace the electrode.
Err 7	Meter cannot recognize the buffer (Wrong buffer)	Make sure you have the correct buffer and that it is fresh. Disconnect, clean and/or replace the electrode.
Err 8	Memory is full	Clear the memory
Err 9	Measurement data cannot be stored twice	---

6.4 Error limits

Message	Description	Range not accepted	
ERR 3	Value out of range	pH	<ul style="list-style-type: none"> FiveEasy™ < 0.00 or > 14.00 pH FiveEasy Plus™ < -2.00 or > 16.00 pH
		mV	< -2000 or > 2000 mV
ERR 4	Buffer temperature out of range	T [°C, °F]	< 5 or > 40 °C, < 41 or > 104 °F
ERR 5	Offset out of range (first cal. point)	Eref1-Eb	≤ -35 or ≥ 35 mV
ERR 6	Slope out of range (following cal. points)	Eref1-Eb	< 85% or > 110%
ERR 7	Wrong buffer	ΔEref1	< 60 mV

6.5 Disposal

In conformance with the European Directive 2012/19/EU on Waste Electrical and Electronic Equipment (WEEE) this device may not be disposed of in domestic waste. This also applies to countries outside the EU, per their specific requirements.

Please dispose of this product in accordance with local regulations at the collecting point specified for electrical and electronic equipment. If you have any questions, please contact the responsible authority or the distributor from which you purchased this device. Should this device be passed on to other parties, the content of this regulation must also be related.



7 Product Portfolio

Meter and Kits	Description	Order No.
F20-Meter	FiveEasy™ pH/mV meter without sensor	30266658
F20-Standard	FiveEasy™ pH/mV meter kit with LE438 sensor	30266626
FP20-Meter	FiveEasy Plus™ pH/mV meter without sensor	30266627
FP20-Standard	FiveEasy Plus™ pH/mV meter kit with LE438 sensor	30266628
FP20-Bio	FiveEasy Plus™ pH/mV meter kit with LE410 sensor	30266629
FP20-Micro	FiveEasy Plus™ pH/mV meter kit with LE422 sensor	30266940
FP20-TRIS	FiveEasy Plus™ pH/mV meter kit with LE420 sensor	30266941

8 Accessories

Item	Order No.
Power adapter	11120270
Electrode arm (includes sensor holder and 2 poles)	30239139
Electrode arm extension (additional pole)	30239140
Rubber caps to cover electrode arm holes (2pcs.)	51302952
Side cover to cover holes for electrode arm poles	30239146
Shorting plug BNC	30133643

Sensors	Order No.
LE438	51340242
LE407	51340330
LE408	51340347
LE409	51340331
LE410	51340348
LE420	51340332
LE422	30089747
LE427	51340333
NTC 30 kOhm, temperature sensor	51300164

Solutions	Order No.
pH 2.00 buffer sachets, 30 x 20 mL	30111134
pH 2.00 buffer solution, 250 mL	51350002
pH 2.00 buffer solution, 6 x 250 mL	51350016
pH 4.01 buffer sachets, 30 x 20 mL	51302069
pH 4.01 buffer solution, 250 mL	51350004
pH 4.01 buffer solution, 6 x 250 mL	51350018
pH 7.00 buffer sachets, 30 x 20 mL	51302047
pH 7.00 buffer solution, 250 mL	51350006
pH 7.00 buffer solution, 6 x 250 mL	51350020
pH 9.21 buffer sachets, 30 x 20 mL	51302070
pH 9.21 buffer solution, 250 mL	51350008
pH 9.21 buffer solution, 6 x 250 mL	51350022
pH 10.01 buffer sachets, 30 x 20 mL	51302079
pH 10.01 buffer solution, 250 mL	51350010
pH 10.01 buffer solution, 6 x 250 mL	51350024
pH 11.00 buffer sachets, 30 x 20 mL	30111135
pH 11.00 buffer solution, 250 mL	51350012
pH 11.00 buffer solution, 6 x 250 mL	51350026
Rainbow sachets I (10 sachets of pH 4.01 / 7.00 / 9.21)	51302068
Rainbow sachets II (10 sachets of pH 4.01 / 7.00 / 10.00)	51302080
Rainbow bottles I (2 x 250 mL of pH 4.01 / 7.00 / 9.21)	30095312
Rainbow bottles II (2 x 250 mL of pH 4.01 / 7.00 / 10.00)	30095313
InLab storage solution (for all InLab pH and redox electrodes), 250 mL	30111142
Electrolyte 3 mol/L KCl, 25 mL	51343180
Electrolyte 3 mol/L KCl, 250 mL	51350072
Electrolyte 3 mol/L KCl, 6 x 250 mL	51350080
HCl/Pepsin solution (removes protein contamination), 250 mL	51350100
Reactivation solution for pH electrodes, 25 mL	51350104

Solutions	Order No.
Thiourea solution (removes silver sulfide contamination), 250 mL	51350102

9 Technical Data F20

General

Power rating AC adapter	Line voltage	100 - 240 V AC ~ ± 10%
	Input frequency	50/60 Hz
	Output voltage	12 V DC = For use with CSA certified (or equivalent approved) power source, which must have a limited circuit output.
Power rating instrument	Input voltage	9 - 12 V =
	Power consumption	1 W
Dimensions	Height (without sensor stand)	70 mm
	Width	227 mm
	Depth	147 mm
	Weight	0.63 kg
Display	LCD	4.3" Segmented LCD
Ambient conditions	Operating temperature	0...40 °C
	Relative humidity	5%...85% (noncondensing) from 31 °C to 40 °C linearly descending to 50%
	Overvoltage category	Class II
	Pollution degree	2
	Maximum operating altitude	2000 m above sea level
	Range of application	For indoor use
Materials	Housing	ABS
	Window	Polymethyl methacrylate (PMMA)

Measurement

Parameters	pH, mV	
Sensor inputs	pH/mV	BNC, impedance > 10 ¹² Ω
	Temperature	RCA (Cinch), NTC 30 kΩ
Connectors	Analog input	yes
pH	Measuring range	0.00...14.00 pH
	Resolution	0.01 pH
	Limits of error	± 0.01 pH
mV	Measuring range	-2000...2000 mV
	Resolution	1 mV
	Limits of error	±1 mV
Temperature	Measuring range	0...100 °C (32...212 °F)
	Resolution	0.1 °C
	Limits of error	± 0.5 °C
	ATC/MTC	Yes
Calibration	Calibration points	3
	Predefined buffer groups	4
	Automatic buffer recognition	Yes
	Calibration methods	Linear
General measurement	Automatic and manual endpoint recording	Yes
	Acoustic endpoint signal	Yes
	Visual endpoint signal	Yes

Data security / storage	Memory size	Current calibration
--------------------------------	-------------	---------------------

10 Technical Data FP20

General

Power rating AC adapter	Line voltage	100 - 240 V AC ~ ± 10%
	Input frequency	50/60 Hz
	Output voltage	12 V DC = For use with CSA certified (or equivalent approved) power source, which must have a limited circuit output.
Power rating instrument	Input voltage	9 - 12 V =
	Power consumption	1 W
Dimensions	Height (without sensor stand)	70 mm
	Width	227 mm
	Depth	147 mm
	Weight	0.63 kg
Display	LCD	4.3" Segmented LCD
Ambient conditions	Operating temperature	0...40 °C
	Relative humidity	5%...85% (noncondensing) from 31 °C to 40 °C linearly descending to 50%
	Overvoltage category	Class II
	Pollution degree	2
	Maximum operating altitude	2000 m above sea level
	Range of application	For indoor use
Materials	Housing	ABS
	Window	Polymethyl methacrylate (PMMA)

Measurement

Parameters	pH, mV	
Sensor inputs	pH/mV	BNC, impedance > 10 ¹² Ω
	Temperature	Cinch, NTC 30 kΩ
Connectors	RS232 interface	yes
	USB interface	yes
	Reference input	yes
pH	Measuring range	-2.00...16.00 pH
	Resolution	0.01 pH
	Limits of error (sensor input)	± 0.01 pH
mV	Measuring range	-2000...2000 mV
	Resolution	1 mV
	Limits of error	±1 mV
Temperature	Measuring range	-5...105 °C (23...221 °F)
	Resolution	0.1 °C
	Limits of error	± 0.3 °C
	ATC/MTC	Yes
Calibration	Calibration points	5
	Predefined buffer groups	4
	Automatic buffer recognition	Yes
	Calibration methods	Linear/segmented

General measurement	Automatic and manual endpoint recording	Yes
	Acoustic endpoint signal	Yes
	Visual endpoint signal	Yes
Data security / storage	Memory size	200 measurements, current calibration

11 Appendix

B1 METTLER TOLEDO USA (Ref. 25 °C)

T [°C]	1.68	4.01	7.00	10.01
5	1.67	4.00	7.09	10.25
10	1.67	4.00	7.06	10.18
15	1.67	4.00	7.04	10.12
20	1.68	4.00	7.02	10.06
25	1.68	4.01	7.00	10.01
30	1.68	4.01	6.99	9.97
35	1.69	4.02	6.98	9.93
40	1.69	4.03	6.97	9.89

B2 METTLER TOLEDO Europe (Ref. 25 °C)

T [°C]	2.00	4.01	7.00	9.21	11.00
5	2.02	4.01	7.09	9.45	11.72
10	2.01	4.00	7.06	9.38	11.54
15	2.00	4.00	7.04	9.32	11.36
20	2.00	4.00	7.02	9.26	11.18
25	2.00	4.01	7.00	9.21	11.00
30	1.99	4.01	6.99	9.16	10.82
35	1.99	4.02	6.98	9.11	10.64
40	1.98	4.03	6.97	9.06	10.46

B3 JJG119 (Ref. 25 °C)

T [°C]	1.680	4.003	6.864	9.182	12.460
5	1.669	3.999	6.949	9.391	13.210
10	1.671	3.996	6.921	9.330	13.011
15	1.673	3.996	6.898	9.276	12.820
20	1.676	3.998	6.879	9.226	12.637
25	1.680	4.003	6.864	9.182	12.460
30	1.684	4.010	6.852	9.142	12.292
35	1.688	4.019	6.844	9.105	12.130
40	1.694	4.029	6.838	9.072	11.975

B4 JIS Z 8802 (Ref. 25 °C)

T [°C]	1.679	4.008	6.865	9.180
5	1.668	3.999	6.951	9.395
10	1.670	3.998	6.923	9.332
15	1.672	3.999	6.900	9.276
20	1.675	4.002	6.881	9.225
25	1.679	4.008	6.865	9.180
30	1.683	4.015	6.853	9.139
35	1.688	4.024	6.844	9.102
40	1.694	4.035	6.838	9.068

To protect your product's future:

METTLER TOLEDO Service assures the quality, measuring accuracy and preservation of value of this product for years to come.

Please request full details about our attractive terms of service.

www.mt.com/phlab

For more information

Mettler-Toledo GmbH

Im Langacher 44
8606 Greifensee, Switzerland
Tel. +41 22 567 53 22
Fax +41 22 567 53 23
www.mt.com/contact

Subject to technical changes.
© Mettler-Toledo GmbH 04/2021
30266869C



30266869